

GNSS+LTE Combination Antenna

GLB318L

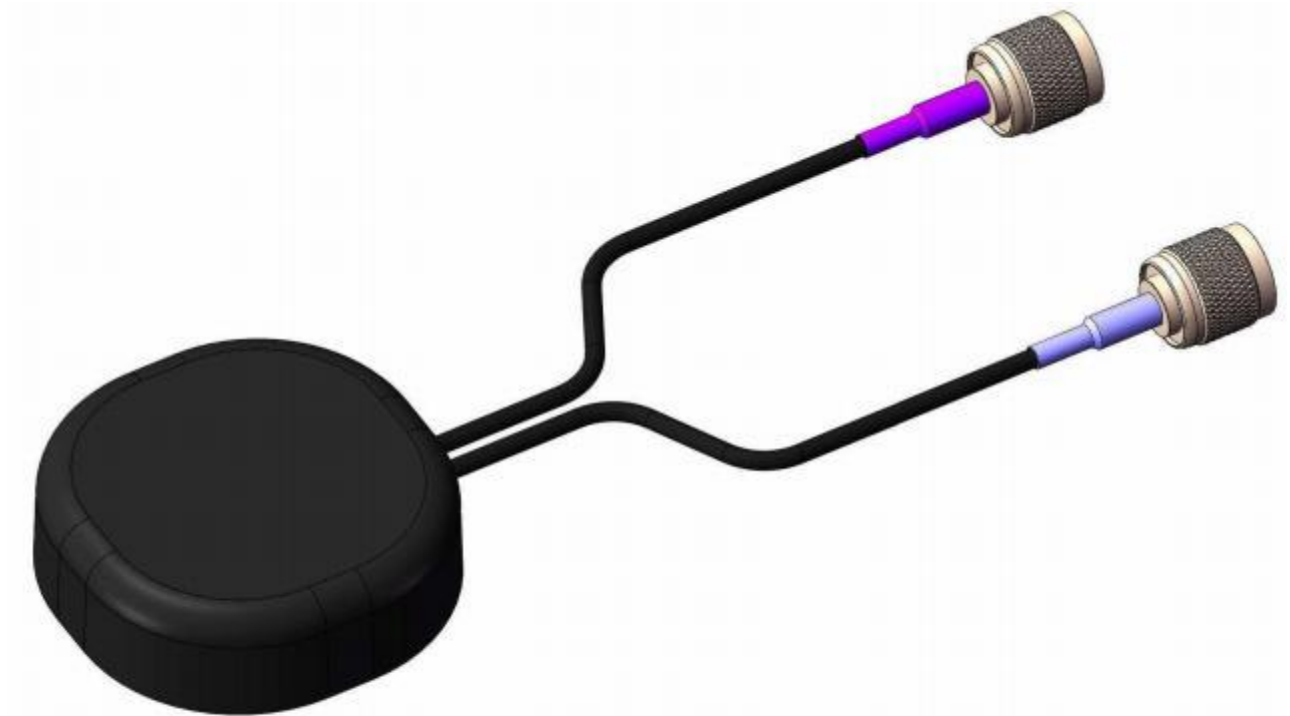

DIMENSIONS

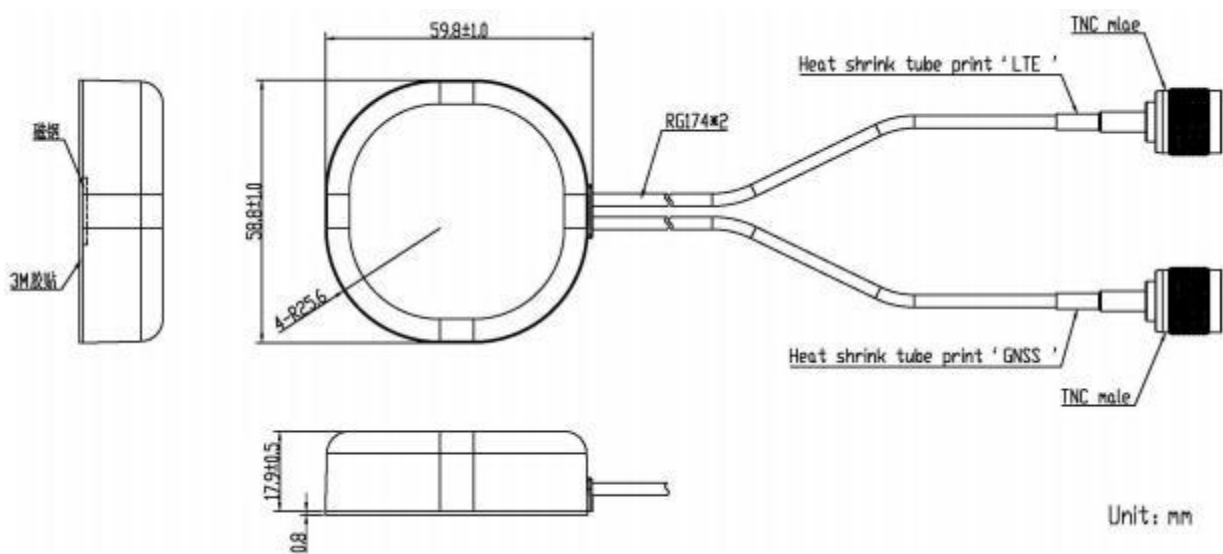

Add: Room 816, Block B,BLDG 18, University Science Park(East), Zhengzhou City,P.R.Henan,China. Zip Code: 450051

Tel: 86-371-60911368

Email: info@global-antenna.com

SPECIFICATIONS

Item		Specifications		
GNSS Antenna (2 pins)	Dielectric Antenna	Frequency Range-MHz	GPS:1561.098~ 1575.42(L1-Band) QZSS: 1563-1587(L1) Galileo: 1559-1591(E1) GLONASS: 1602.0-1614.94	
		Polarization	RHCP	
		Gain	5dBic (Zenith)	
		V.S.W.R	<1.5	
		Impedance	50Ω	
		Dimension	33.5*33.5*6mm	
		Axial Ratio	3dB	
	LNA	Gain	28±2dB	
		Noise Figure	<1.5dB	
		V.S.W.R	<2.0	
		Supply Voltage	3~5.5V DC	
		Current Consumption	<25mA	
	LTE Antenna		Frequency Range	698~960MHz/1710~2690MHz
			V.S.W.R	≤3.0
Polarization			Linear	
Gain			2dBi	
Impedance			50Ω	
DC resistance			10KΩ	
Mechanical		Cable	RG174 or others	
		Connector	SMA or others	
		Radome Material	ABS	
		Mounting Method	Magnet/Adhesive	
Environmental		Operating Temperature	-40℃~+85℃	
		Relative Humidity	Up to 95%	
		Ingress Protection	IP66	
		Vibration	10 to 55Hz with 1.5mm amplitude 2hours	
		Environmentally Friendly	ROHS Compliant	

Add: Room 816, Block B,BLDG 18, University Science Park(East), Zhengzhou City,P.R.Henan,China. Zip Code: 450051

Tel: 86-371-60911368 **Email:** info@global-antenna.com

Radiation Pattern

GNSS Antenna

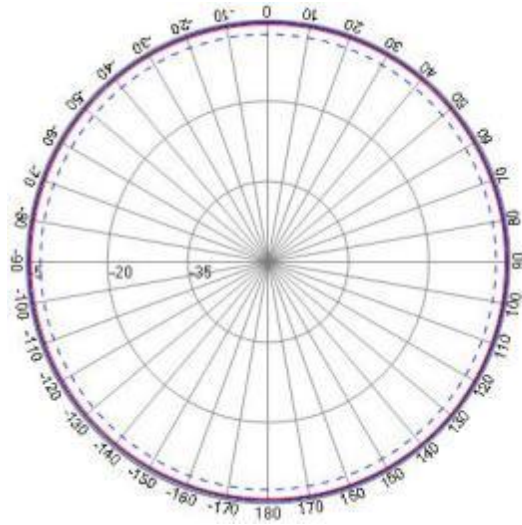

XY-PLANE

Freq: 1602
 Freq: 1561
 Freq: 1575

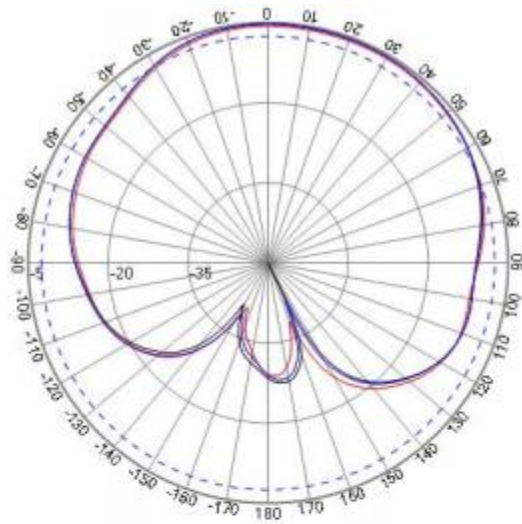
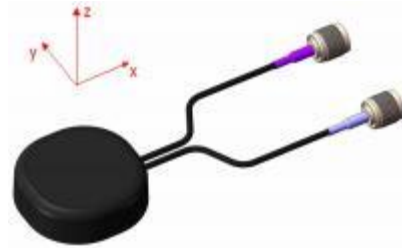

XZ-PLANE

Freq: 1602
 Freq: 1561
 Freq: 1575

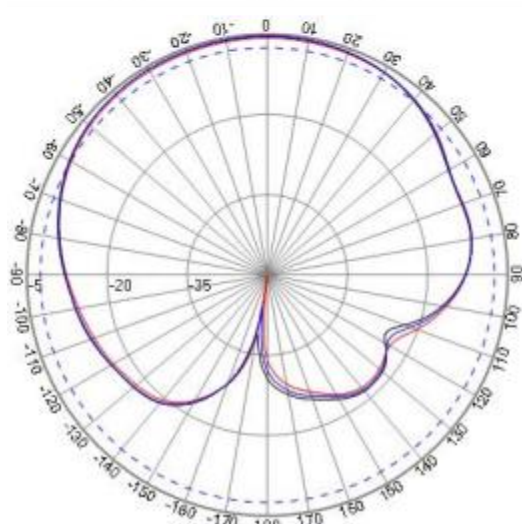

YZ-PLANE

Freq: 1602
 Freq: 1561
 Freq: 1575

Add: Room 816, Block B,BLDG 18, University Science Park(East), Zhengzhou City,P.R.Henan,China. Zip Code: 450051

Tel: 86-371-60911368

Email: info@global-antenna.com

LTE Antenna

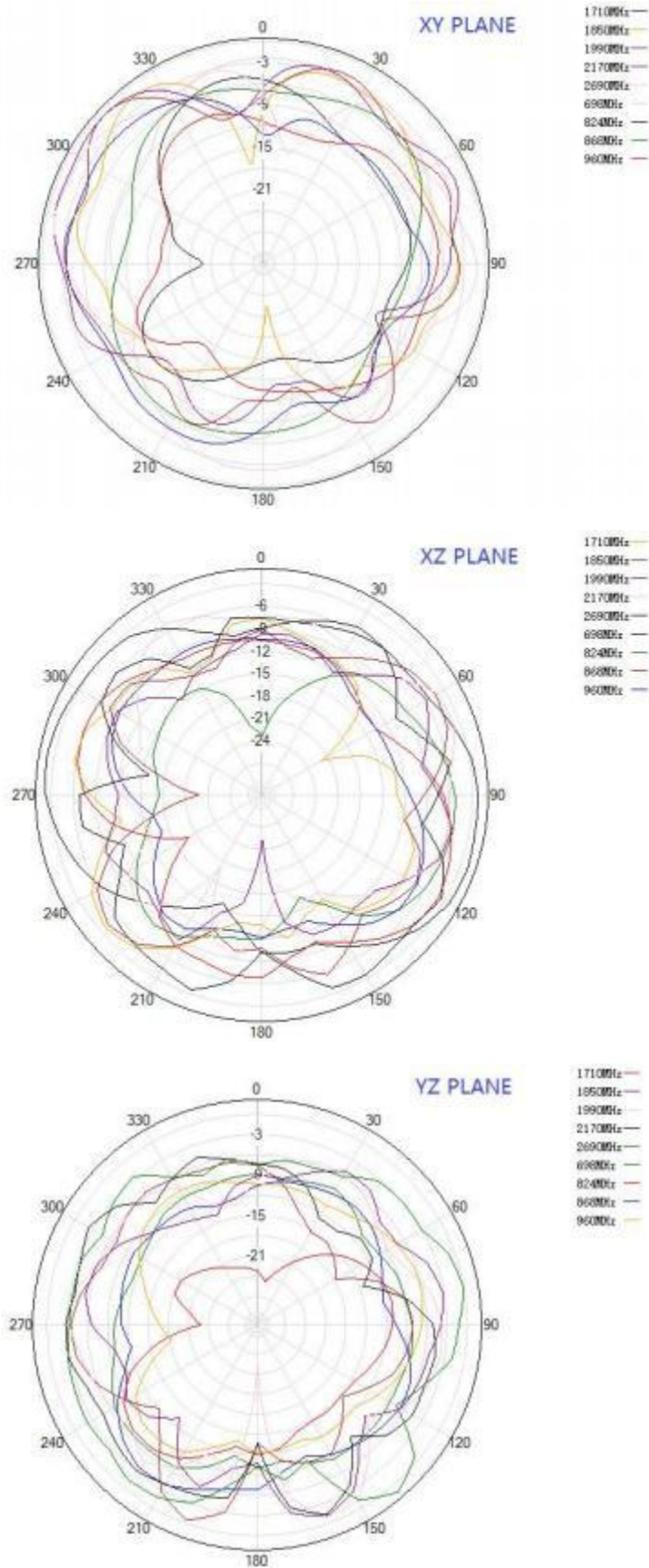

Add: Room 816, Block B,BLDG 18, University Science Park(East), Zhengzhou City,P.R.Henan,China.
Zip Code: 450051

Tel: 86-371-60911368

Email: info@global-antenna.com