

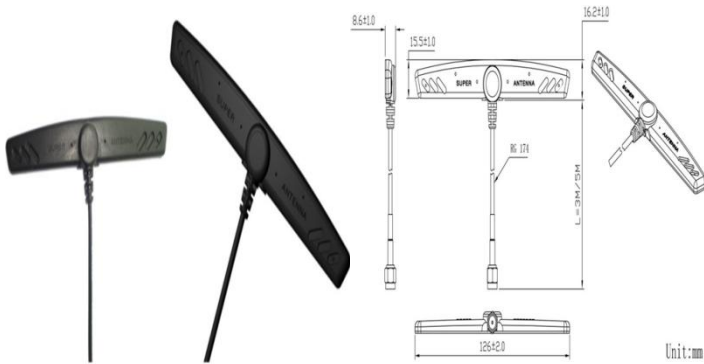

GLOBAL EAST ASIA TECHNOLOGY CO.,LIMITED

<https://www.global-antenna.com>



Item	Specifications	
Antenna	Frequency Range	698~960/1710~2700MHz
	Polarization	Linear
	Gain	2dBi
	V.S.W.R	<2.0
	Impedance	50Ω
	PCB Dimension	126*15.5*8.6mm
Mechanical	Cable	RG174 or LMR100
	Connector	SMA/FAKRA or others
	Radome Material	ABS
	Mounting Method	Adhesive
Environmental	Operating Temperature	-40°C~+85°C
	Relative Humidity	Up to 95%
	Vibration	10 to 55Hz with 1.5mm amplitude 2hours
	Environmentally Friendly	ROHS Compliant